

2MP Starlight Network IR Mini Bullet Camera

IPC2122SR3-UPF40 (60)-C



Key Features

Optics

- Starlight illumination
- Day/night functionality
- Optical glass window with higher light transmittance
- IR anti-reflection window to increase the infrared transmittance
- Smart IR , up to 30 m (98 ft) IR distance
- 2D/3D DNR (Digital Noise Reduction)

Compression

- Ultra 265, H.265, H.264, MJPEG
- Embedded smart algorithm
- Triple streams
- 9:16 corridor mode

Network

- ONVIF Conformance

Structure

- Wide temperature range: -35°C to 60°C (-31°F to 140°F)
- Wide voltage range of ±25%

- IP67

Specifications

	IPC2122SR3-UPF40-C	IPC2122SR3-UPF60-C
Camera		
Sensor	1/2.9", progressive scan, 2.0 megapixel, CMOS	
Lens	4.0mm@ F1.6	6.0mm@ F1.6
Angle of view(H)	82.0°	52.1°
Shutter	Auto/Manual, 1/6~1/100000 s	
Minimum Illumination	Colour: 0.003 Lux (F1.6, AGC ON) 0 Lux with IR on	
Day/Night	IR-cut filter with auto switch (ICR)	
Digital noise reduction	2D/3D DNR	
S/N	>52dB	
IR Range	Up to 30m (98 ft) IR range	
Defog	Digital Defog	
WDR	DWDR	
Video		
Video Compression	Ultra 265 ,H.265, H.264, MJPEG	
H.264 code profile	Baseline profile, Main Profile, High Profile	
Frame Rate	Main Stream: 2MP(1920×1080) Max. 30fps; Sub Stream: 2MP(1920×1080) Max. 30fps; Third Stream: D1(720×576) Max. 30fps	
9:16 Corridor Mode	Supported	
HLC	Supported	
BLC	Supported	
OSD	Up to 8 OSDs	
Privacy Mask	Up to 8 areas	
ROI	Up to 8 areas	
Motion Detection	Up to 4 areas	
Smart		
Behavior Detection	Intrusion, cross line, motion detection	
Intelligent Identification	Face detection, Defocus, Scene Change	
Statistical Analysis	People counting	
General Function	Watermark, IP Address Filtering, Tampering Alarm, Access Policy, ARP Protection, RTSP Authentication, User Authentication	
Network		
Protocols	IPv4, IGMP, ICMP, ARP, TCP, UDP, DHCP, PPPoE, RTP, RTSP, RTCP, DNS, DDNS, NTP, FTP, UPnP, HTTP, HTTPS, SMTP, 802.1x, SNMP	
Compatible Integration	ONVIF(Profile S), API	
Interface		
Network	1 RJ45 10M/100M Base-TX Ethernet	
General		
Power	12 V DC±25%, PoE (IEEE802.3 af)	

	Power consumption: Max 6.4 W
Dimensions (L × W × H)	157.3 × 62.4 × 63mm (6.2" × 2.5" × 2.5")
Weight	0.45 kg (0.99 lb)
Working Environment	-35°C ~ +60°C (-31°F ~ 140°F), Humidity :10%~95% RH(non-condensing)
Ingress Protection	IP67
Reset Button	Supported

Dimensions

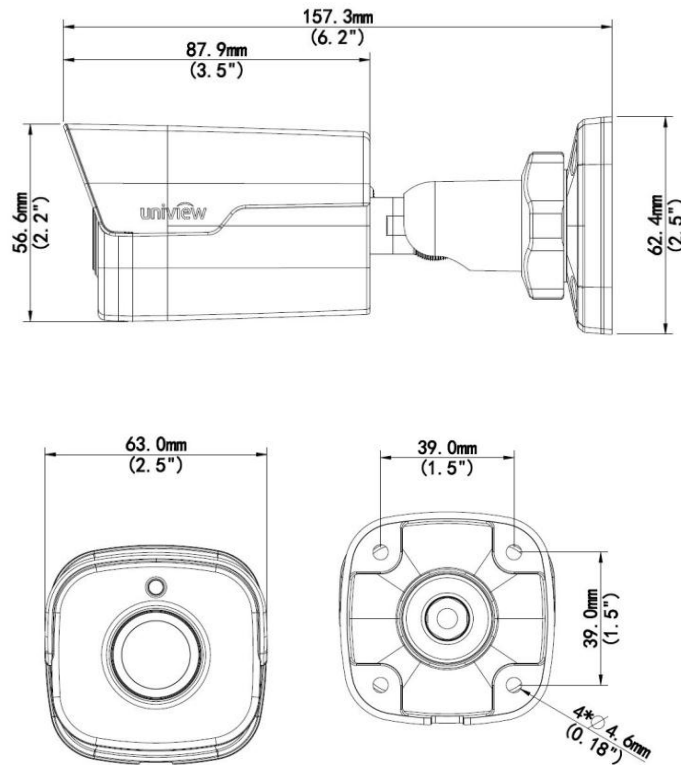

Accessories

Installation mode	Accessories	Description
Wall mount	\	Mounting pedestal is included in the Product package
Ceiling mount	\	Mounting pedestal is included in the Product package
Pole mount	TR-UP06-A-IN TR-JB05-IN junction box + TR-UP06-A-IN	TR-A01-IN waterproof joint for junction is optional

Zhejiang Uniview Technologies Co., Ltd.

Building No.10, Wanlun Science Park, Jiangling Road 88, Binjiang District, Hangzhou, Zhejiang, China (310051)

Email: overseasbusiness@uniview.com; globalsupport@uniview.com

<http://www.uniview.com>

©2016-2017 Zhejiang Uniview Technologies Co., Ltd. All rights reserved.

*Product specifications and availability are subject to change without notice.